

# AQUA<sup>TM</sup> TANKS

**The  
Natural  
Choice**

0109



**Aqua Tanks™ is a division of Galloway International Ltd** who are internationally recognised as one of the leaders in the concept, design, development and manufacture of thermoplastic products and systems. We have over 20 years experience in global and domestic markets.



Aqua Tanks™ has earned the reputation of providing high quality polyethylene storage tanks for water and chemicals and our product and colour range is extensive. We manufacture tanks from 295 litres to 25,210 litres and produce a range of filters and other tank accessories which makes us New Zealand's number one selling brand.

### **Our Tanks**

Every Aqua Tank™ is manufactured to the Australian and New Zealand standard AS/NZS 4766:2006 and produced from virgin food grade material. Our tanks are moulded in one piece and are designed to ensure that unnecessary stresses are adequately contained within the unique ribbed side walls of the tank. The ribs determine that the column of water rests on the ground. Additional strength is moulded into the tank through the combination of moulded, ribbed and domed construction.

### **Manufacturing**

The Aqua Tanks™ manufacturing plant in East Tamaki, Auckland incorporates a unique process; rotational moulding. The moulding process virtually ensures stress-free products which have no joints. The tanks are one-piece in construction.

### **Polyethylene**

The product used to make Aqua Tanks™ is an extremely tough and durable lightweight thermoplastic material. The colour and ultra-violet stabilizers are compounded to give long term resistance and stability to harsh sun. No chemical reactions take place during the manufacturing process and consequently there is no tainting of water with polyethylene. The material is recyclable and can be repaired by a heat welding process if damaged.



Beige

Mist Green

Karaka

Heritage Green

Khaki

# The Natural Choice

## Largest range of tanks in New Zealand

Environmentally friendly material

Vent in the tank dome allows the tank to breathe

Prevents algae growth

Resists ultra-violet damage

Easy fitting of inlet & overflow

Lighter than timber or concrete

Non toxic food grade (FDA approved)

Light and easy to transport

Manufactured to AS/NZ4766:2006

Will not taint contents

Osmosis free

Maintenance-free

New Zealand design No 23758

No leaching

Includes fittings for easy connection

The only tank that is fully ribbed and domed for proven strength

Four lifting lugs for convenience

AQ25200

AQ16000

AQ10000

AQ05000



Capacity  
25,210 ltrs

Capacity  
16,095 ltrs

Capacity  
10,046 ltrs

Capacity  
5,020 ltrs









Black	Light Grey	Dark Grey	White	Mountain Blue	Heritage Red
-------	------------	-----------	-------	---------------	--------------

Tank Model	Capacity		Diameter (mm)		Height (mm)		Weight (kg)	Outlet Qty x Size
	Litres	Gallons	Base	Top	Overall	to Inlet		
<b>AQ Range: Above-Ground Water Storage Tanks</b>								
AQ25200	25,210	5,553	3,555	3,555	2,900	2,660	375	2 x 50mm BSP
AQ16000	16,095	3,545	3,555	3,555	2,010	1,800	290	2 x 50mm BSP
AQ10000	10,046	2,213	2,180	2,180	2,995	2,720	210	1 x 50mm BSP
AQ05000	5,020	1,106	1,785	1,830	2,335	2,110	110	1 x 50mm BSP
AQ02700	2,555	563	1,300	1,362	2,100	1,950	65	1 x 40mm BSP
AQ02500	2,510	553	1,600	1,600	1,570	1,550	65	1 x 40mm BSP
AQ01600	1,725	380	1,290	1,350	1,685	1,660	45	1 x 25mm BSP
AQ01100	1,110	244	900	965	1,945	1,920	35	1 x 25mm BSP
AQ00800	774	170	1,190	1,352	820	720	35	1 x 25mm BSP
AQ00600	598	132	814	975	1,125	1,060	25	1 x 25mm BSP
AQ00450	475	105	895	895	1,065	1,040	25	1 x 25mm BSP
AQ00300	295	65	810	965	640	570	18	1 x 25mm BSP

Tank Model	Capacity		Diameter (mm)		Height (mm) Overall	Weight (kg)	Outlet Qty x Size
	Litres	Gallons	Base	Top			
<b>ST Range: Stackable Water Storage Tanks</b>							
ST06000	5,681	1,250	1,877	2,278	2,000	135	1 x 50mm BSP
ST05000	5,020	1,073	1,850	2,270	1,750	100	1 x 40mm BSP
ST03000	2,840	625	1,450	1,850	1,695	80	1 x 40mm BSP
ST02000	1,894	417	1,150	1,580	1,600	50	2 x 40mm BSP

Tank Model	Capacity		Length mm	Width mm	Height (mm) Above Ground	Weight (kg)	Outlet Qty x Size
	Litres	Gallons					
<b>HZ Range: Underground &amp; Multi-Purpose Tanks</b>							
HZ05000	5,011	1,103	3,340	1,240	1,450	260	1 x 50mm BSP
HZ04500	4,502	991	3,900	1,260	1,710	220	-
HZ03000 AG/UG	3,044	670	2,380	1,370	1,515 / 1,800	170	1 x 40mm BSP
HZ01900 AG/UG	1,865	411	1,450	1,360	1,500 / 1,800	100	1 x 40mm BSP
HZ00500	495	109	1,180	800	1,050	30	1 x 40mm BSP

See above table for dimensions

					<b>AQ00800</b>	<b>AQ00450</b>
	<b>AQ02700</b>	<b>AQ02500</b>	<b>AQ01600</b>	<b>AQ01100</b>		
					Capacity 774 ltrs	Capacity 475 ltrs
					<b>AQ00600</b>	<b>AQ00300</b>
						
	Capacity 2,555 ltrs	Capacity 2,510 ltrs	Capacity 1,725 ltrs	Capacity 1,110 ltrs	Capacity 598 ltrs	Capacity 295 ltrs



1 x HZ01900 Underground Installation



2 x HZ03000 Underground Tanks in series.



1 x HZ05000 Partially Buried under a deck



HZ04500 Multi-Purpose Underground Tank



ST02000

ST03000

ST05000

ST06000



Aqua Filter

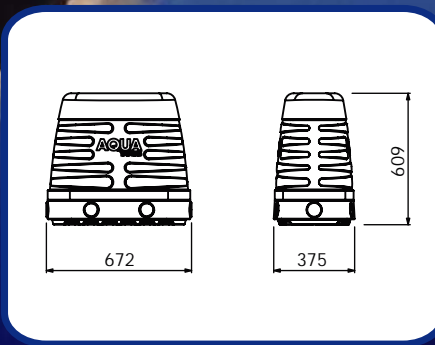

Aqua Pump Cover



Water Level Indicator

" Specifications are correct at time of printing. In keeping with our policy of continual product innovation & improvement, we reserve the right to alter specifications at any time. Please check all measurements where tolerances are critical"

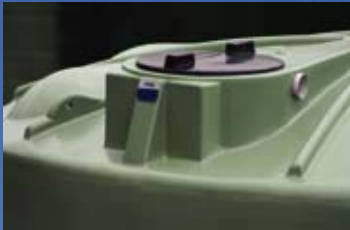

The AQ25200 and AQ16000 have a vent, lifting lugs and the facility to simply install an inlet and overflow pipe



All Aqua Tanks™ are delivered complete with a fitting for easy installation. Large tanks have two fittings; one on each side of the tank.



All large Aqua Tanks™ have additional strength moulded into the tanks through a combination of ribbed and domed construction.



## Installation

Comprehensive installation instructions are provided by us at the time of delivery. It is critical that the installation instructions are followed to protect your pro-rata warranty. Installation instructions are also available on our website [www.aquatanks.co.nz](http://www.aquatanks.co.nz).

## Delivery

We can arrange delivery of your tank anywhere in the North Island generally within 7 working days from date of order. Please contact one of our team to confirm delivery to your area.

## Dealers throughout the North Island

We have Aqua Tank™ Dealers throughout the North Island. Many of our dealers have stock of tanks so that you can see, touch and feel the quality of our tanks. Please visit our website at [www.aquatanks.co.nz](http://www.aquatanks.co.nz) to identify the location of a dealer near you.

## New Zealand Standard

All of our tanks are manufactured to the relevant standard for water storage tanks AS/NZS 4766:2006. In addition, our AQ25200 (25,209 litre tank) is certified to hold the amount of water stated in our promotional material.

## Warranty

All Aqua Tanks™ (AQ-Range) come with a pro-rata warranty which warrants the tank against any defects in material.

Dealer Name:

**AQUA™**  
**TANKS**

HEAD OFFICE

36 Cryers Road, East Tamaki, 2013

P.O. Box 58-632 Greenmount 2141, Auckland, New Zealand

Free phone: **0800 370 007**

Phone: 64-9-273 5666 Fax: 64-9-273 5668

Email: [info@aquatanks.co.nz](mailto:info@aquatanks.co.nz) Website: [www.aquatanks.co.nz](http://www.aquatanks.co.nz)